

Amplified Loudspeaker Controllers

Installation and User Guide



MODELS

ALC-404D

ALC-1604D

ALC-3202D

communitypro.com

D0000246.00



Important Safety Instructions

 THE TRIANGLE WITH THE LIGHTNING BOLT IS USED TO ALERT THE USER TO THE RISK OF ELECTRIC SHOCK.

 THE TRIANGLE WITH THE EXCLAMATION POINT IS USED TO ALERT THE USER TO IMPORTANT OPERATING OR MAINTENANCE INSTRUCTIONS.

 THE CE-MARK INDICATES THE COMPLIANCE WITH THE LOW VOLTAGE AND ELECTROMAGNETIC COMPATIBILITY.

 SYMBOL FOR EARTH/GROUND CONNECTION.

 SYMBOL INDICATING THAT THE EQUIPMENT IS FOR INDOOR USE ONLY.

 SYMBOL FOR CONFORMITY WITH DIRECTIVE 2012/19/EC OF THE EUROPEAN PARLIAMENT ON WASTE ELECTRICAL AND ELECTRONIC EQUIPMENT (WEEE).

 DO NOT USE THE UNIT AT ALTITUDES ABOVE 2000 M.

 DO NOT USE THE UNIT IN TROPICAL ENVIRONMENT.

 WARNING: TO REDUCE THE RISK OF ELECTRIC SHOCK, DO NOT ATTEMPT TO OPEN ANY PART OF THE UNIT. NO USER-SERVICEABLE PARTS INSIDE. REFER SERVICING TO QUALIFIED SERVICE PERSONNEL.

 CONNECTION TO THE MAINS SHALL BE DONE ONLY BY A ELECTRO-TECHNICAL SKILLED PERSON ACCORDING THE NATIONAL REQUIREMENTS OF THE COUNTRIES WHERE THE UNIT IS SOLD.

 DO NOT USE THIS ALC IF THE ELECTRICAL POWER CORD IS FRAYED OR BROKEN.

 TO AVOID ELECTRICAL SHOCK, DO NOT TOUCH ANY EXPOSED SPEAKER WIRING WHILE THE ALC IS OPERATING.

 DO NOT SPILL WATER OR OTHER LIQUIDS INTO OR ON THE ALC.

 NO NAKED FLAME SOURCES SUCH AS LIGHTED CANDLES SHOULD BE PLACED ON THE ALC.

 WARNING TO PREVENT INJURY, THIS APPARATUS MUST BE SECURELY ATTACHED TO THE FLOOR/WALL IN ACCORDANCE WITH THE INSTALLATION INSTRUCTIONS.

 THIS DEVICE MUST BE POWERED EXCLUSIVELY BY EARTH CONNECTED MAINS SOCKETS IN ELECTRICAL NETWORKS COMPLIANT TO THE IEC 364 OR SIMILAR RULES

 DISCONNECT THE AC MAINS SOURCE BEFORE ATTEMPTING TO CLEAN ANY PART OF THE ALC

 COMMUNITY SUGGESTS PLUGGING THE ALC-3202D TO A 16 A RATING, C OR D CURVE, 10 KA SECTIONING BREAKER.

 IT IS HIGHLY RECOMMENDED TO UNPLUG THE OUTPUT CONNECTORS BEFORE PROCEEDING WITH THE SELF CHECK PROCEDURE

 THE TESTING SIGNALS MIGHT CAUSE LOUDSPEAKER IMPAIRMENTS.

 OUTPUT TERMINALS ARE HAZARDOUS: WIRING CONNECTION TO THESE TERMINALS REQUIRES INSTALLATION BY AN INSTRUCTED PERSON AND THE USE OF READY MADE LEADS.

 PROPERLY FIT THE AC MAINS PLUG TO THE ALC INLET. BEFORE POWERING THIS ALC, VERIFY THAT THE CORRECT VOLTAGE RATING IS BEING USED.

 VERIFY THAT YOUR MAINS CONNECTION IS CAPABLE OF SATISFYING THE POWER RATINGS OF THE DEVICE.

 TAKE CARE TO LOCK THE OUTPUT TERMINAL BEFORE SWITCHING THE DEVICE ON.

Note: Every effort has been made to ensure that the information contained in this manual was complete and accurate at the time of printing. However, due to ongoing technical advances, changes or modifications may have occurred that are not covered in this manual. The latest version is available at communitypro.com.

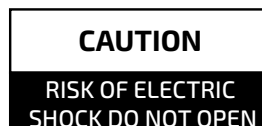

This unit has been engineered and manufactured to ensure your personal safety. But IMPROPER USE CAN RESULT IN POTENTIAL ELECTRICAL SHOCK OR FIRE HAZARD.

In order not to defeat the safeguards incorporated into this product, observe the following basic rules for its installation, use and service. Please read these "Important Safeguards" carefully before use.

- Read these instructions.
- Keep these instructions.
- Heed all warnings.
- Follow all instructions.
- Do not use this equipment near water.
- Clean only with a dry cloth.
- Do not block any ventilation openings. Install in accordance with the manufacturer's instructions.
- Do not install near any heat sources such as radiators, heat registers, stoves, or other apparatus that produce heat.
- Do not defeat the safety purpose of the polarized or grounding-type plug. A polarized plug has two blades with one wider than the other. A grounding-type plug has two blades and a third grounding prong. The wide blade or the third prong are provided for your safety. If the provided plug does not fit into your outlet, consult an electrician for replacement of the obsolete outlet.
- Protect the power cord from being walked on or pinched particularly at plugs, convenience receptacles, and the point where they exit from the apparatus.
- Only use attachments/accessories specified by the manufacturer.
- Use only with the rack, cart, stand, tripod, bracket, or table specified by the manufacturer, or sold with the apparatus. When a cart is used, use caution when moving the cart/apparatus combination to avoid injury from tip-over. 
- Unplug this apparatus during lightning storms or when unused for long periods of time.
- Refer all servicing to qualified service personnel. Servicing is required when the apparatus has been damaged in any way, such as power-supply cord or plug is damaged, liquid has been spilled or objects have fallen into the apparatus, the apparatus has been exposed to rain or moisture, does not operate normally, or has been dropped.
- The apparatus shall be connected to a MAINS socket outlet with a protective earth grounding connection
- Where the MAINS plug or an appropriate coupler is used as the disconnect device, the disconnect device shall remain readily operable.

IMPORTANT: The manufacturer cannot be held responsible for damages caused to persons, things or data due to an improper or missing ground connection.

Contact the authorized service center for ordinary and extraordinary maintenance.

It is absolutely necessary to verify these fundamental requirements of safety and, in case of doubt, require an accurate check by qualified personnel.

WEEE Directive

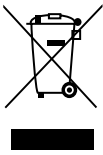

This symbol indicates that when the end user wishes to discard this product, it must be sent to separate collection facilities for recovery and recycling. By separating this product from other household-type waste, the volume of waste sent to incinerators or landfills will be reduced and natural resources will thus be conserved.

The Waste Electrical and Electronic Equipment Directive (WEEE Directive) aims to minimize the impact of electrical and electronic goods on the environment.

All of our products are marked with the WEEE symbol; this indicates that this product must NOT be disposed of with other waste.

For more information about where you can send your waste equipment for recycling, please contact your local distributor.

EC Declaration of Conformity

Community Professional Loudspeakers
333 East Fifth Street
Chester, PA 19013
USA



We declare that under our sole responsibility the products:

Model Names:

ALC-404D
ALC-1604D
ALC-3202D

Intended use: Professional Audio Amplifier

Are in conformity with the provisions of the following EC Directives, including all amendments, and with national legislation implementing these directives:

2014/35/EU Low Voltage Directive
2014/30/EU Electromagnetic Compatibility Directive
2011/65/EU RoHs Directive



The following harmonized standards apply:

EN 60065:2014 /AC:2016
EN 55032:2012
EN 55035:2017
EN 55103-2:2009 /IS:2012
EN 61000-3-3:2013
EN 61000-3-2:2014

Complies with:

CAN/CSA 60065:16
UL Standard No. 60065-2015

In an effort to reduce the quantity of printed material while enhancing the quality of content, we have decided to adopt a new approach for the production of this quick guide.

Vital information has been condensed in two pages, and all illustrations and tables follow. Each section's color bar (ex. ) refers to the outlined area on front or rear panel of the ALC image and the corresponding information tables. Call-out bubbles  guide you to specific elements of those sections.

Please take time to read and understand all warnings and safety instructions on the previous page of this manual.

ArmoníaPlus is a trademarked control software product from Powersoft S.p.A.

Packing List

The box contains the following:

1x ALC-3202D (with Phoenix connectors plugged in)
1x Phoenix MC 1,5/4-ST-3,81 - 1803594 plug
3x Phoenix MC 1,5/6-ST-3,81 - 5447900 plug
1x Phoenix PC 5/4-STF1-7,62 - 177859 plug
3x IEC power cord
1x User guide

OR

1x ALC-404D or ALC-1604D (with Phoenix connectors plugged in)
1x Phoenix MC 1,5/4-ST-3,81 - 1803594 plug
3x Phoenix MC 1,5/12-ST-3,81 - 1803675 plug
1x Phoenix PC 5/8-STF1-7,62 - 177891 plug
3x IEC power cord
1x User guide

Preliminary operations

Location

Install your Community Amplified Loudspeaker Controller (ALC) in well ventilated rack cabinets.

Secure both front and rear brackets to the rack.

Connect the AC Mains connector to a circuit breaker.

Install the ALC far from EMF emitting devices.

Avoid placing the ALC close to heat generating sources.

Cooling

The ventilation openings must not be impeded by any item, keep a distance of at least 19.7 in. (50 cm) from the front and rear ventilation openings of the ALC.

Community ALCs implement a forced-air cooling system to maintain constant operating temperatures. Air enters from the front panel, exiting at the back of the unit.

The cooling system features variable-speed DC fans controlled by the heat sink mounted sensors. This ensures that fan noise and internal dust accumulation are kept to a minimum.

In the rare event of overheating, sensing circuits shut down all channels until the ALC cools down to a safe operating temperature. Normal operation is resumed automatically without the need for user intervention.

ALCs can be stacked one on top of the other, leave one rack unit empty every four to guarantee adequate air flow.

Cleaning

Use a dry cloth for cleaning the chassis and the front panel. Air filter cleaning should be scheduled in accordance with the dust levels in the ALC's operating environment.

In order to clean the vent filters remove the front cover by firmly gripping the outermost black panels and pull them outwards

Use compressed air to remove the dust from filters, or wash them with clean water (let the filter dry thoroughly before reinstalling them).

AC Mains Supply

ALCs implement an universal switching mode power supply with power factor correction operating in the range from 100 VAC up to 240 VAC $\pm 10\%$.

AC mains connection is in the rear panel through the IEC C20 inlet, the approved power cord is provided.

Switching the ALC On and Off

Once properly powered (power cord inserted, sectioning breaker closed), the system can be either ON or in STANDBY mode depending on its state at latest power off.

In order to toggle the ALC between ON and STANDBY press and hold the power button for 3 seconds. Please consider that the operating condition can be modified by the REMOTE ON and REMOTE OFF configuration.

Energy Save

The Smart Rails Management technology implemented in the power supply unit allows to reduce the power consumption when the input signal falls under a defined threshold.

When On, Energy Save is active on each channel independently.

If the signal is missing for more than 30 minutes on all channels, the auto standby is applied and the main PSU is turned off to further save energy (*Time out time is selectable via ArmoníaPlus*). Normal operation is resumed in a matter of milliseconds when an incoming signal is detected.

In order to activate the Energy Save feature, operate the NRG SAVE dip switch on the rear panel.

Breaker Save

This feature may be activated when the power grid is unable to provide enough current to continuously drive the loads, or when the number of ALCs connected to the same outlet is such that one can reach the critical power absorption of the line.

When activated, the Breaker Save halves the maximum continuous current absorption from the mains. This slightly reflects on the overall performance of the system, reducing the available output power.

In order to activate the Breaker Save feature, locate the BRK SAVE switch on the rear panel.

Remote On/Off

Remote ON/OFF is available through the dedicated terminals on the rear panel.

Both terminals respond to the differential voltage between the contacts: a voltage difference in the range $5V_{DC} - 24V_{DC}$ triggers the control. Any voltage exceeding $28V_{DC}$ may damage the input circuitry.

The couple of terminals act depending on the actual state of the ALC, in accordance with the following table.

REMOTE ON	REMOTE OFF	ALC STATE
$V_{diff} \geq 5V$	Any	Force Turn ON
$V_{diff} < 3V$	$V_{diff} \geq 5V$	Force Turn OFF
$V_{diff} < 3V$	$V_{diff} < 3V$	No Change (Keep either standby or in current state)

Gain selection

ALCs can operate with different gain applied to the input signal. This feature is designed to match the voltage of the input signal.

A proper combination of the position of two GAIN switches on the rear panel sets the operating gain of the amplifier

Connections

Signal Grounding

There is no ground switch or terminal on the ALCs. The unit's signal grounding system is automatic. In order to limit hum and/or interference entering the signal path, use balanced input connections.

In the interests of safety, the unit MUST always operate with electrical safety earth connected to the chassis via the dedicated Protective Earth \oplus wire.

Analog Audio Input Connections

Analog input connections are made via the Phoenix MC 1,5/6-ST-3,81 5447900 connector on the ALC-3202D (or via the Phoenix MC 1,5/12-ST-3,81 1803675 connector on the ALC-404D or ALC-1604D).

Remote Level Adjustment

The level of each channel can be remotely adjusted by means of a linear 10 k Ω potentiometer connected to the input LEVEL connector.

When the CH1 MSTR switch is in the OFF position the remote level potentiometers work independently on each separate channel.

When the CH1 MSTR switch is in the ON position the remote level potentiometer of channel 1 acts as a master level, controlling the volume of all channels.

The remote level controls are in series with the level adjustment knobs in the front panel.

Digital Audio Input Connection

All ALCs accept two/four input streams from the Dante® connection through the Dante® port. Cabling must comply to TIA/EIA-568-B and adopt the T568B scheme pinout.

In order to implement a Dante® network, a computer running Dante® Controller have to be used. Dante® Controller is a software application that manages devices on the network. ALCs are automatically discovered and displayed in Dante® Controller with the default identifier:

MODELNAME-SERIAL (e.g. ALC-3202D-71520).

Ethernet Connection

The port labeled Ethernet is designed to remotely control the ALC via an Ethernet connection through a personal computer and Powersoft ArmoníaPlus System Manager software.

Powersoft recommends the use of Ethernet Cat5 straight through patch cables with pin/pair assignments TIA/EIA-568-B, i.e. T568B.

Output Connections

Output connections are made via the Phoenix PC 5/4-STF1-7,62 177859 port (or PC 5/8-STF1-7,62 177891 port ALC-404D/1604D).

Any mixed configuration of low and high impedance output loads can be made: in order to set the load configuration, each channel is provided with four DIP switches.

Hi-Z 70V/100V Operations

Any channel can drive 70V/100V (Hi-Z) distributed line loudspeakers. To connect any channel's output to a 70V/100V line, set the rear panel DIP switch corresponding to the channel.

When using Community ALC's with factory-authored loudspeaker presets, it is not necessary to use the built-in HPF (High Pass Filter) DIP switches on the rear of the amplifier. While these switches can select a HPF of 35Hz or 70Hz, each Community 70V / 100V loudspeaker preset already includes a HPF appropriate for the selected loudspeaker model.

Low-Z 2Ω Load Operation

The 2Ω switch allows activation of all output channels set to match the low impedance operating condition (i.e. in Low-Z configuration) optimizing the performance with very low loads, by limiting the maximum output voltage to 85 V_{peak} per channel.

When using ALC's with Community-authored loudspeaker presets this switch becomes redundant and can be ignored. Each loudspeaker preset already includes limiters preset to values that will limit voltages to safe operating levels.

If using an ALC without a Community-authored loudspeaker preset, use this switch as intended for 2Ω loads. **Never connect loads lower than 2Ω to any output channel on any ALC under any circumstances.**

Diagnostics - GPO - Alarms

ALCs provide a pair of paralleled general purpose output connections per channel: one Normally Open \oplus NO and one Normally Closed \ominus NC.

The connections are available on the back panel via the 6-pin (ALC-3202D) or 12-pin (ALC-404D/1604D) Phoenix connectors.

When the amplifier is in normal operating condition the NO contacts are closed, while the NC contacts are open, and vice-versa.

These contacts are used to report potentially dangerous faults or generally unsafe operation conditions by toggling alarm switches relative to the following events, and any fault preventing the normal operation of an output channel:

No AC mains (i.e. system shutdown)

Thermal stress (the system temperature is too high and the thermal protection is engaged)

Short circuit in output wiring (either the loudspeaker or the line is in short)

ALC is in Standby

All ALCs feature further monitoring on pilot tone and output load through ArmoníaPlus System Manager.

Self Check

The self check procedure tests the ALC status and reports the user in case of failures.

After few minutes, at the end of the self check procedure, a combination of lit LED in the LED panel provides information about the amplifier status.

In order to exit the self check test and resume normal operations, press the self check push button once **6**.

If self check cannot be started because of a fault, the check LED will blink fast, while a reassuring slow blink is an indication of a completed self check procedure.

Pilot Tone Monitoring

The detection of a mismatch in the input pilot tone parameters (frequency and voltage level) can be used to trigger the backup policy and activate an alert through the general purpose output switch.

The output pilot tone detection relies on an external signal passing through the ALC or the internal post DSP pilot tone generator; in both cases any mismatch between the detected signal and the set thresholds triggers the general purpose output switches.

Networking

ALCs support star network topology via the Ethernet port and Dante® networking via the Dante® port.

IP Addressing

Factory default network settings are DHCP/AutoIP.

In order for the ALC to self-configure when connected to an existing LAN or PC. Fixed IP policy can also be adopted and configured through ArmoníaPlus System Manager.

If a DHCP server is not active within the network, the ALC platform initiates a stateless address auto-configuration (i.e. Zero-configuration networking methodology). It self-assigns a local numeric network address (of the type 169.254.x.y – 172.31.*.* for the secondary network if present – with a subnet mask 255.255.0.0) and automatically distributes and resolves the host names of the networking devices.

Both ArmoníaPlus and the ALC must belong to the same subnet. If a DHCP server is present on the network and an ALC is in AUTO IP, networking may become unstable.

IMPORTANT: As a rule of thumb, turn the DHCP server ON before connecting the ALCs.

IP addressing of an ALC is established during the bootstrap: when the amplifier discovers a DHCP server on the network during the startup, it negotiates the networking parameters. If the ALC does not reveal a DHCP server on the network during the startup, it sets itself in AUTO IP mode.

ArmoníaPlus System Manager

ArmoníaPlus System Manager is the configuring interface that allows system setting and customization of the ALCs. ArmoníaPlus can be installed on a PC running Windows (7 and higher). Download ArmoníaPlus System Manager for free from the website: <http://www.communitypro.com/armoniaplus>

Input Selection and Backup Policy

It is possible to select among two input signal sources per channel: analog and Dante® streams. ArmoníaPlus System Manager software provides an interface to select the input source.

Furthermore ALCs implement a backup policy aimed to improve reliability against signal fault. By assigning a bus priority to the two different input sources per channel, the system is able to automatically switch to a reliable input connection in case of signal drop or pilot tone mismatch.

Output Load Monitoring

Through the ArmoníaPlus System Manager software it is possible to set the thresholds on the load impedance, at given frequency, that trigger the general purpose output of any channel in ALCs.

Location

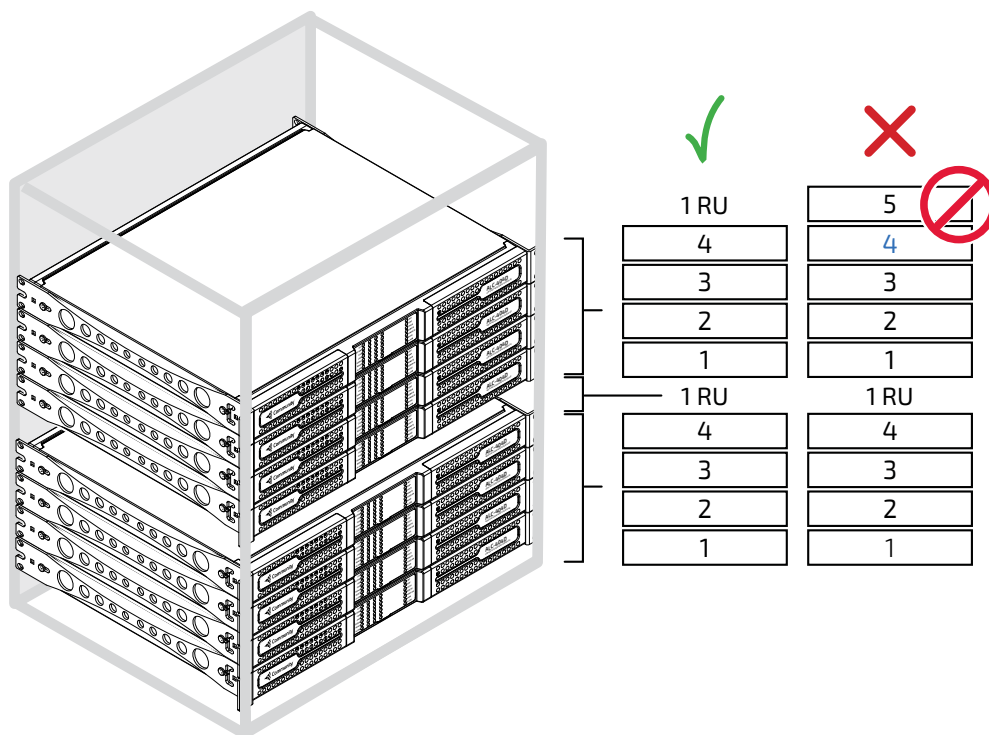

Cooling

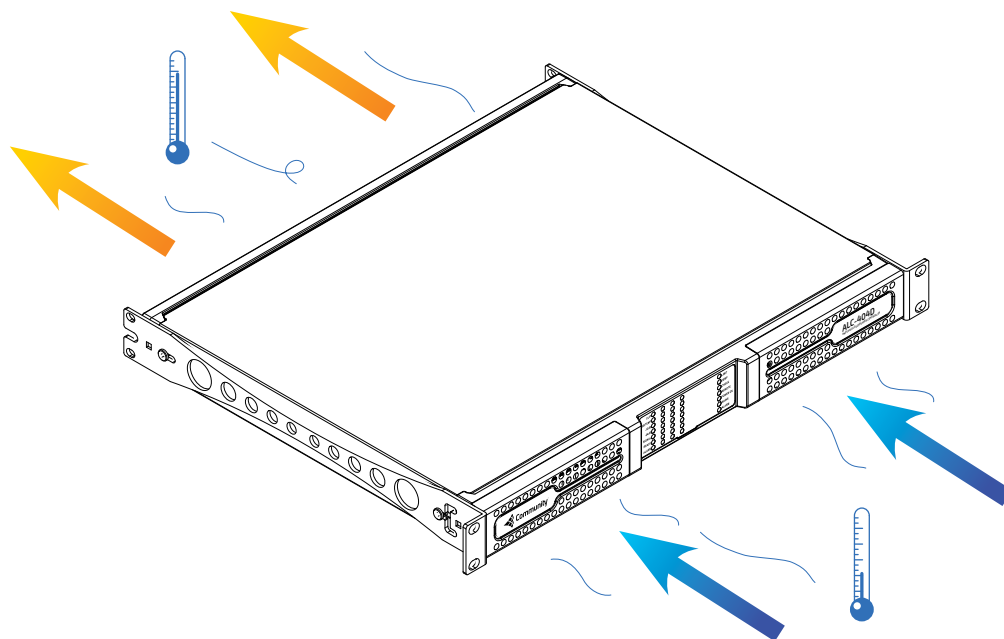

Exposing the Control Panel

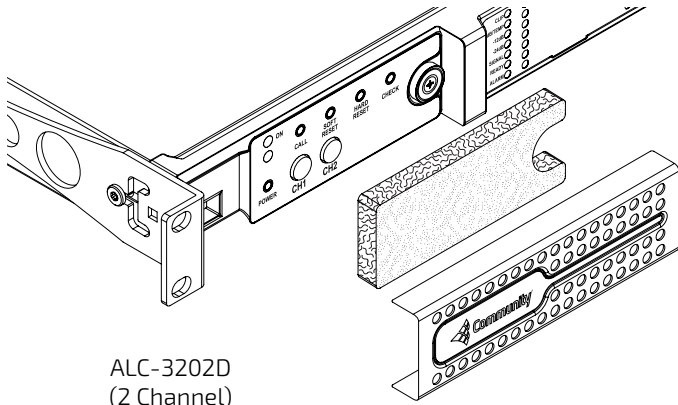

ALC-3202D
(2 Channel)

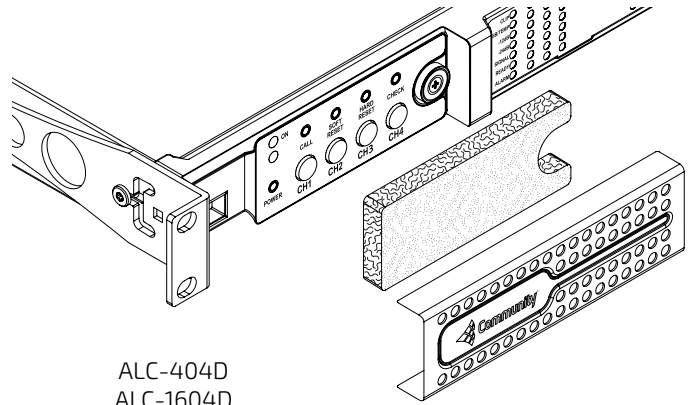

ALC-404D
ALC-1604D
(4 Channel)

Dimensions

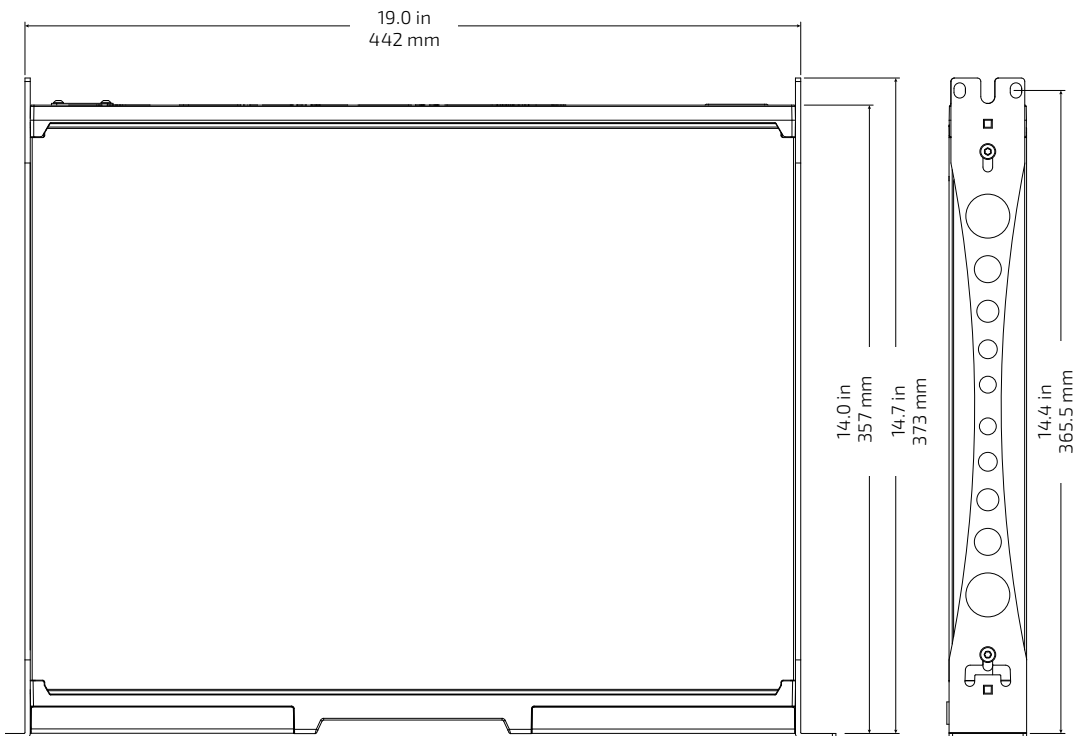

Front Panel

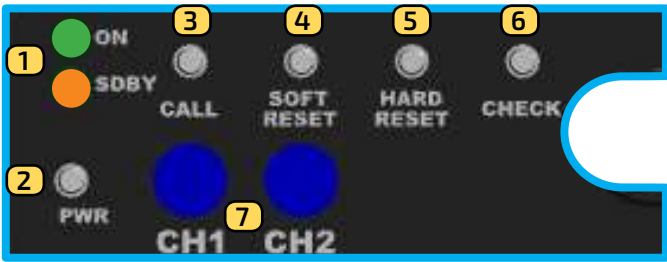

Control Panel

- 1 Operating Mode LEDs (ON/STANDBY)
- 2 Power pushbutton
- 3 ArmoníaPlus Callback pushbutton
- 4 Soft Reset pushbutton
- 5 Hard Reset pushbutton
- 6 Self Check pushbutton
- 7 CH1, CH2 attenuators (+ CH3, CH4 - ALC-404D, ALC-1604D)

LED Panel

- 8 Channel Status LED meters
- 9 System Status LEDs

Serial Port

Reserved for service operations.

Rear Panel

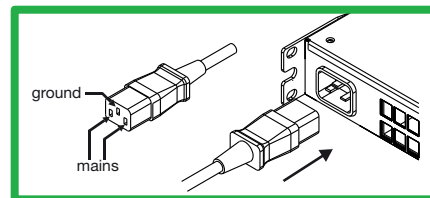
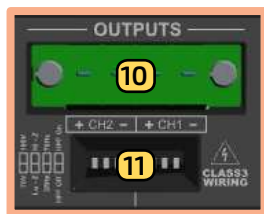
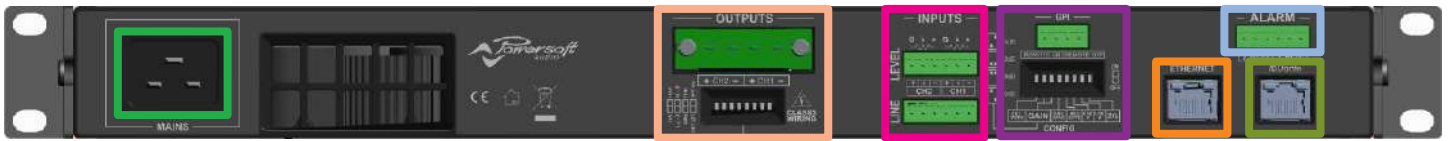

Output section

- 10 Output connector
- 11 Output configuration Dip Switches

AC Mains Connector

IEC C19

	Low-Z	High-Z	100V	70V	HPF @ 35 Hz	HPF @ 70 Hz
A	●					
B		●	●			
C		●	●		●	
D		●	●			●
E		●		●		
F		●		●	●	
G		●		●		●

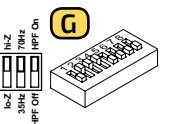
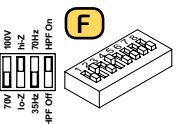
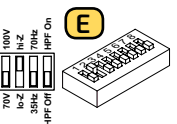
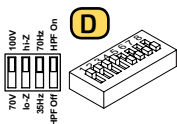
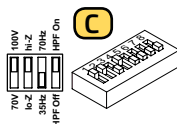
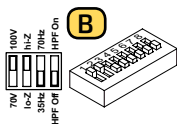
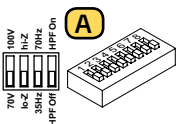

ALC-3202D
Single Ended
(Flipped view)

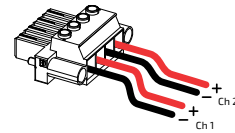

Bridged
(Flipped view)

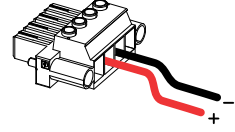

10

ALC-404D or ALC-1604D
Single Ended
(Flipped view)

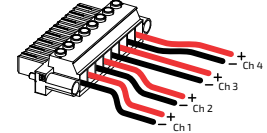

Bridged
(Flipped view)

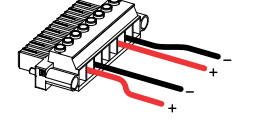

Rear Panel (continued)

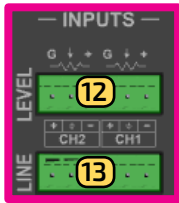

Input section

- 12 Remote Level connector
- 13 Line Input connector

ALC-3202D

Input

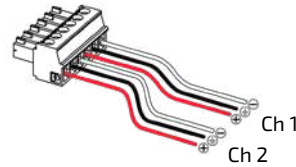

Remote Level

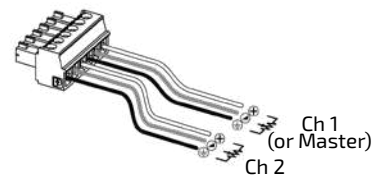

ALC-404D or ALC-1604D

Input

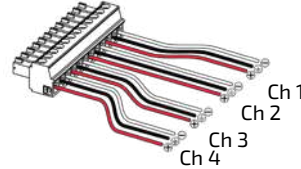

Remote Level

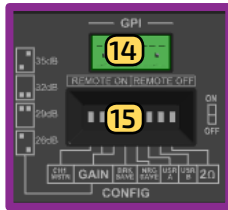
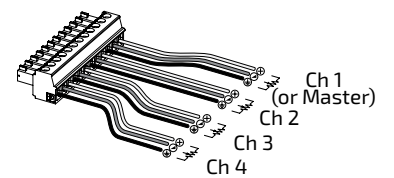

Remote On/Off

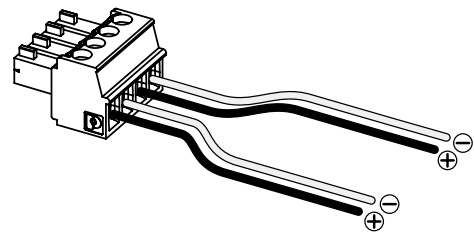

Remote On/Off-Configuration dip switches

- 14 Remote On/Off connector (Phoenix MC 1,5/4-ST-3,811803594)
- 15 System Configuration dip switches

Input Gain Selection									
26 dB	29 dB	32 dB	35 dB	CH1 Master	BRK Save	NRG Save	USR A	USR B	2 Ω*
2-3	2-3	2-3	2-3	1	4	5	6	7	8

* ALC-404D and ALC-1604D models only. (ALC3202 does not have 2 Ω operation).



Alarm

GPO/Alarm connector

ALC-3202D

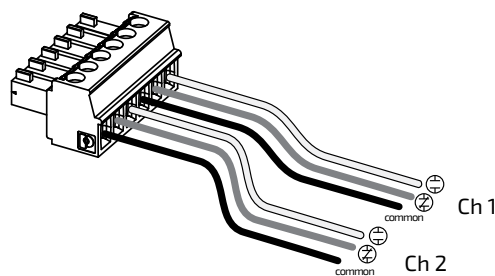

ALC-404D or ALC-1604D

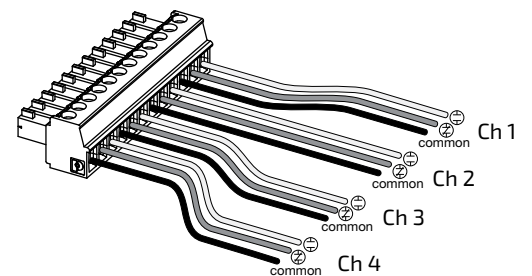

Ethernet and Dante® ports

- 16 Ethernet port (RJ45)
- 17 Dante® port (RJ45)

RJ45	Color code (TIA/EIA-568-B)	Pin
	ORANGE / WHITE	1
	ORANGE	2
	GREEN / WHITE	3
	BLUE	4
	BLUE / WHITE	5
	GREEN	6
	BROWN / WHITE	7
	BROWN	8

LED Charts

LED Bars, signal metering

8

Color	Signal Metering	Warnings	
		Lighting	Description
ORANGE	Clipping ALC User Limiter	—	—
YELLOW	-6dB	SOLID ON	Thermal warning Thermal protection engaged
		FLASHING	Auto Standby
GREEN	-12dB	—	—
GREEN	-24dB	—	—
GREEN	-60dB	SOLID ON	Signal presence
		BLINKING	Channel muted
GREEN	—	SOLID ON	Channel ready
RED	—	SOLID ON	Channel fault ¹

¹ Red LED lights on in case of any kind of channel fault that prevents the normal channel operating.

Lighting	Timings	Description
FLASHING	100 ms ON 900 ms OFF	
BLINKING	500 ms ON 500 ms OFF	

LED Bar, system status

9

Color	Name	Warnings	
		Lighting	Description
ORANGE	LIMIT	FLASHING	Breaker Save Enabled
		SOLID ON	Breaker Save limiting power draw
YELLOW	TEMP	SOLID ON	Thermal warning Thermal protection engaged
ORANGE	CHECK	SOLID ON	System self checking
		BLINKING	Self check completed
		FAST BLINKING	Self Check Unavailable
GREEN	REMOTE	SOLID ON	Connected to ArmoniaPlus
		OFF	Not connected to ArmoniaPlus
GREEN	POWER ON	SOLID ON	System ready
		OFF	System off
GREEN	MAINS	SOLID ON	AC mains voltage within the operating range
		OFF	Undervoltage
		FLASHING	Over/Undervoltage Warning
		FAST BLINKING	Overvoltage
RED	ALARM	BLINKING	Mains FUSES blown
		SOLID ON	PSU fault ¹ OR Critical Faults

¹ Red LED lights on in case of any kind of PSU fault that prevents normal operating.

Lighting	Timings	Description
FLASHING	100 ms ON 400 ms OFF	
FAST BLINKING	100 ms ON 100 ms OFF	
BLINKING	500 ms ON 500 ms OFF	

Operating mode LEDs

1

Color	Name	Operating mode	
		Standby	Power On
GREEN	POWER ON	—	SOLID ON
ORANGE	STANDBY	SOLID ON	—
ORANGE	AUTO STANDBY	BLINKING	—
ORANGE	ERROR CODE	BLINK COUNTER	—

Control Panel

Label	Label	Type	Action	Description
2	POWER	Pushbutton	keep pressed for 3 seconds	Toggle system ready / standby mode
3	CALL	Pushbutton	press	Highlight the ALC in the ArmoniaPlus workspace
4	SOFT RESET ¹	Pushbutton	keep pressed for 3 seconds	Reset network parameters to factory default
5	HARD RESET ¹	Pushbutton	keep pressed for 3 seconds	Reboot the system
6	CHECK	Pushbutton	keep pressed for 3 seconds	Start the self-checking procedure ³
7	CH1 ²	Potentiometer	turn counter-clockwise	Attenuate the output level of the signal on channel 1
	CH2 ²	Potentiometer	turn counter-clockwise	Attenuate the output level of the signal on channel 2

The push-buttons are disabled when connected to Armonia.

- Keep pressed both the SOFT RESET button and the HARD RESET button for at least 3 seconds to completely reset the ALC to its factory default configuration (any preset stored in the internal memory will be lost and replaced with a flat preset).
- The potentiometer is in series with the remote level control so it can be used to limit the output volume regardless of any remote adjustment.
- Press again to resume normal operations.

Self Check

6

	System OK.
	Power supply fault
	AC Mains voltage out of range (over/under voltage)
	PSU temperature out of range
	Fan Error
	Channel# Output Waveform non-conformity
	Channel# Temperature out of range
	Channel# Output current measurement non-conformity ¹

1. An 8Ω dummy load is needed to measure the output current. If the dummy load is not applied the system reports a fault.

Warranty and Assistance

Community Professional Loudspeakers guarantees its manufactured products to be free from defective components and factory workmanship for a period of time starting from the date of purchase printed on Community's (or any of its Authorized Dealer's) invoice to the end customer.

The standard warranty period is: 48 months for rack ALC units.

All warranty repairs and retrofits must be performed at Community facilities or at an Authorized Service Center at no cost for the purchaser. Warranty exclusion: Community's warranty does not cover product malfunctioning or failure caused by: misuse, abuse, repair work or alterations performed by non-authorized personnel, incorrect connections, exposure to harsh weather conditions, corrosive environments, mechanical damages (including shipping accidents), and normal wear and tear. Community will perform warranty services provided that the product is not damaged during transportation.

Return of Goods

Goods can be returned to Community only after they have been granted a Return Merchandise Authorization (RMA) number to be attached to the external packaging. Community (or its Authorized Service Center) has the right to refuse any returned good without a RMA number.

Repair or Replacement

Community reserves the right to repair or replace any defective goods covered under the product warranty at its sole discretion and as it deems best.

Cost and Responsibility of Transport

The purchaser (or end user/customer) is solely responsible for all transportation costs and risks associated with sending warranty covered goods to Community or its Authorized Service Center. Community will assume full responsibility and cover all costs incurred to send the goods back to the purchaser (or end user/customer).

Warranty

Assistance

All servicing and repairs for Community ALCs is handled by Powersoft Worldwide, but processing of warranty claims must be submitted to Community first. Please follow the instructions below in case of any difficulties.

There are no user-serviceable parts in the ALC unit. Refer to qualified technical personnel for servicing. If your ALC needs repair, contact Community's Technical Service Department.

- Take a note of each serial number of the units to be returned.
- Completely fill out the defect report form for each unit to be returned. Send the completed defect report form to service@communitypro.com.

After having applied the aforementioned procedure, the Community service manager will work with Powersoft to determine the appropriate Service Center to which the ALCs must be shipped and the product's warranty status. Community will also provide RMA numbers for each unit.

Do not contact Powersoft directly for Community ALC servicing or repairs. All claims must be processed by Community.

In-Warranty Repairs

The service repair will be free of charge for the customer.

Out of Warranty Issues

- The service costs are calculated on the local rate applied from the service center and supervised by Community.
- The repair time has been set by Community and it's equally applied in all the authorized service center
- The unit will be evaluated by a technician, and the service center will provide the customer with the estimated costs.
- The repair will only take place once the customer has approved the estimated costs.
- The customer will pay the shipping charges once the repair has been completed, depending on the countries' standard procedures.

For any inquiries please email Community's Technical Service Department at service@communitypro.com

Shipping the product for factory service

- Record each serial number of the units to be returned.
- Fill out completely the defect report form for each unit to be returned.
- Send the completed defect report form to the following email address: service@communitypro.com

After having applied the aforementioned procedure, you will receive an email from Community containing the Return Merchandise Authorization (RMA form) for each unit returned and a Service Center shipping address. All ALCs must be shipped to the specific Service Center address provided by Community, units shipped to any other location will be rejected.

Phone Support Hours

Monday - Friday 8.30 AM to 5.00 PM Eastern Time Zone
ph: +1 610 876-3400

Important Note: Mark or write the RMA# on the outside of the box in a prominent place. If the RMA# is not displayed on the outside of the box, the shipment will be rejected and sent back to the customer.

Dead on Arrival (D.O.A.) Procedure

In case of a "dead on arrival" D.O.A. product, we ask the customer to contact the Community Service Department, mentioning the serial number of the faulty unit.

The D.O.A. unit will be replaced completely without any additional charges!

Important Note: To avoid any warranty issue, do NOT tamper with, or operate the D.O.A. unit in any way. Community declines any D.O.A. product warranty service if the returned unit has been tampered with or misused by the customer.



©2019 Community Professional Loudspeakers

Community Professional Loudspeakers
333 East Fifth Street, Chester, PA 19013-4511 USA
Phone (610) 876-3400 • Fax (610) 874-0190

ALC_InstallGuide v: 01MAR2019